

600mA, Ultra-Fast Transient Response LDO Regulator

General Description

The RT9001 series are CMOS low dropout regulators optimized for ultra-fast transient response. The devices are capable of supplying 600mA of output current with a dropout voltage of 580mV respectively.

The RT9001 series are is optimized for CD/DVD-ROM, CD/RW or wireless communication supply applications. The RT9001 regulators are stable with output capacitors as low as 1μF. The other features include ultra low dropout voltage, high output accuracy, current limiting protection, and high ripple rejection ratio.

The devices are available in fixed output voltages range of 1.2V to 4.5V with 0.1V per step. The RT9001 regulators are available in 3-lead SOT-223 package.

Ordering Information

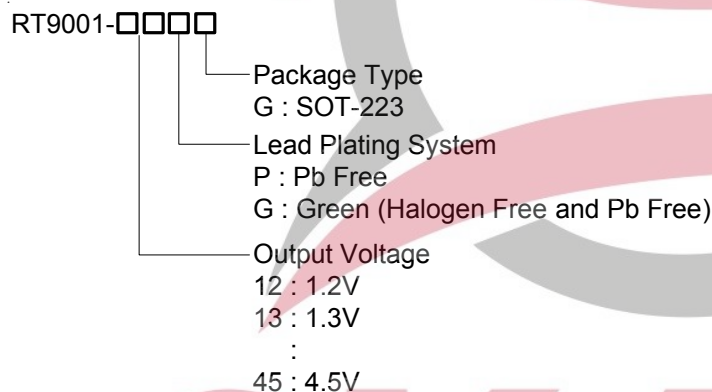

Note :

Richtek products are :

- ▶ RoHS compliant and compatible with the current requirements of IPC/JEDEC J-STD-020.
- ▶ Suitable for use in SnPb or Pb-free soldering processes.

Marking Information

For marking information, contact our sales representative directly or through a RichTek distributor located in your area.

Features

- Low Quiescent Current (Typically 220μA)
- Guaranteed 600mA Output Current
- Low Dropout Voltage : 580mV at 600mA
- Wide Operating Voltage Ranges : 3V to 5.5V
- Ultra-Fast Transient Response
- Tight Load and Line Regulation
- Current Limiting Protection
- Thermal Shutdown Protection
- Only low-ESR Ceramic Capacitor Required for Stability
- Custom Voltage Available
- RoHS Compliant and 100% Lead (Pb)-Free

Applications

- CD/DVD-ROM, CD/RW
- Wireless LAN Card/Keyboard/Mouse
- Battery-Powered Equipment
- XDSL Router
- PCMCIA Card

Pin Configurations

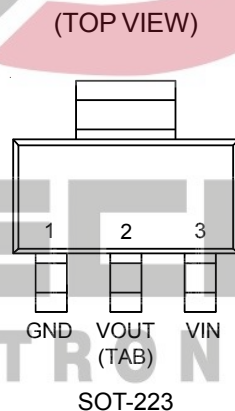

Typical Application Circuit

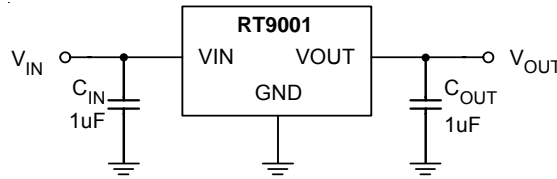

Note: To prevent oscillation, a 1μF minimum X7R or X5R dielectric is strongly recommended if ceramics are used as input/output capacitors. When using the Y5V dielectric, the minimum value of the input/output capacitance that can be used for stable over full operating temperature range is 3.3μF. (see Application Information Section for further details)

Functional Pin Description

Pin Name	Pin Function
VIN	Supply Input.
VOUT	Regulator Output.
GND	Common Ground.

Function Block Diagram

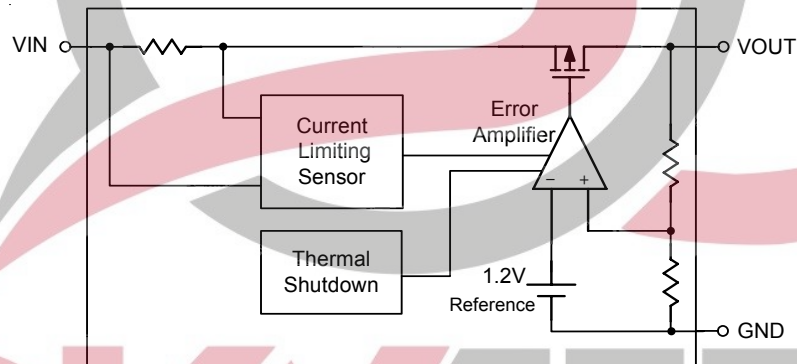

Absolute Maximum Ratings (Note 1)

- Supply Input Voltage ----- 6.5V
- Power Dissipation, $P_D @ T_A = 25^\circ\text{C}$
SOT-223 ----- 0.625W
- Package Thermal Resistance (Note 2)
SOT-223, θ_{JA} ----- 160°C/W
- Lead Temperature (Soldering, 10 sec.) ----- 260°C
- Junction Temperature ----- 150°C
- Storage Temperature Range ----- -65°C to 150°C
- ESD Susceptibility (Note 3)
HBM (Human Body Mode) ----- 2kV
MM (Machine Mode) ----- 200V

Recommended Operating Conditions (Note 4)

- Supply Input Voltage ----- 2.8V to 5.5V
- Junction Temperature Range ----- -40°C to 125°C

Electrical Characteristics

($V_{IN} = V_{OUT} + 1V$ or $V_{IN} = 2.8V$ whichever is greater, $C_{IN} = 1\mu\text{F}$, $C_{OUT} = 1\mu\text{F}$, $T_A = 25^\circ\text{C}$, unless otherwise specified)

Parameter	Symbol	Test Conditions	Min	Typ	Max	Unit
Output Voltage Accuracy	ΔV_{OUT}	$I_{OUT} = 1\text{mA}$	-1	--	3	%
Current Limit	I_{LIM}	$R_{LOAD} = 1\Omega$	600	--	--	mA
Quiescent Current (Note 5)	I_Q	$I_{OUT} = 0\text{mA}$	--	220	300	μA
Dropout Voltage (Note 6)	V_{DROP}	$I_{OUT} = 600\text{mA}$	--	580	--	mV
Line Regulation	ΔV_{LINE}	$V_{IN} = (V_{OUT} + 0.3V)$ to 5.5V, $I_{OUT} = 1\text{mA}$	--	0.2	--	%/V
Load Regulation (Note 7)	ΔV_{LOAD}	$1\text{mA} < I_{OUT} < 600\text{mA}$	--	30	55	mV
Power Supply Rejection Rate	PSRR	$f = 1\text{kHz}$, $C_{OUT} = 1\mu\text{F}$	--	-55	--	dB
Thermal Shutdown Temperature	T_{SD}		--	170	--	°C
Thermal Shutdown Hysteresis	ΔT_{SD}		--	40	--	°C

Note 1. Stresses listed as the above "Absolute Maximum Ratings" may cause permanent damage to the device. These are for stress ratings. Functional operation of the device at these or any other conditions beyond those indicated in the operational sections of the specifications is not implied. Exposure to absolute maximum rating conditions for extended periods may remain possibility to affect device reliability.

Note 2. θ_{JA} is measured in the natural convection at $T_A = 25^\circ\text{C}$ on a low effective thermal conductivity test board of JEDEC 51-3 thermal measurement standard.

Note 3. Devices are ESD sensitive. Handling precaution recommended.

Note 4. The device is not guaranteed to function outside its operating conditions.

Note 5. Quiescent, or ground current, is the difference between input and output currents. It is defined by $I_Q = I_{IN} - I_{OUT}$ under no load condition ($I_{OUT} = 0\text{mA}$). The total current drawn from the supply is the sum of the load current plus the ground pin current.

Note 6. The dropout voltage is defined as $V_{IN} - V_{OUT}$, which is measured when V_{OUT} is $V_{OUT(NORMAL)} - 100\text{mV}$.

Note 7. Regulation is measured at constant junction temperature by using a 20ms current pulse. Devices are tested for load regulation in the load range from 1mA to 600mA respectively.

Typical Operating Characteristics

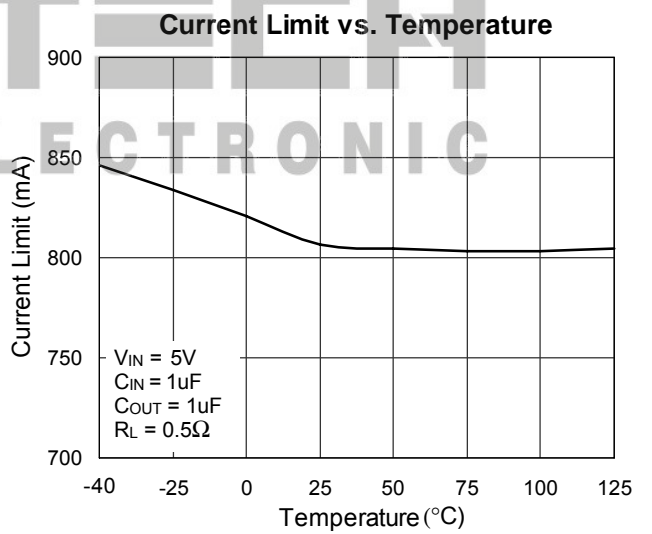
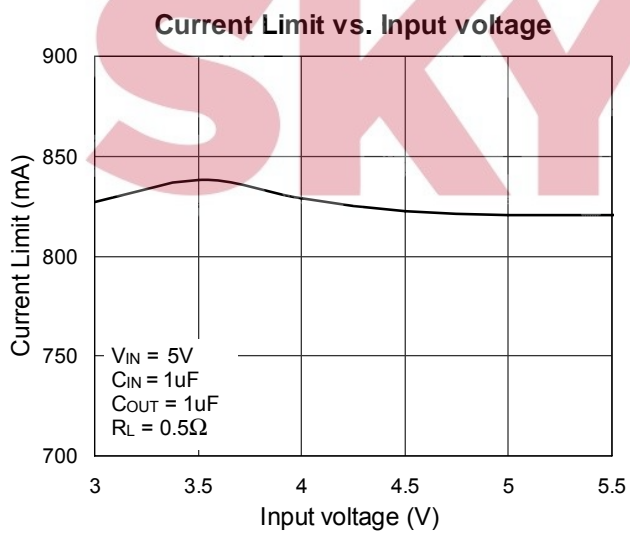
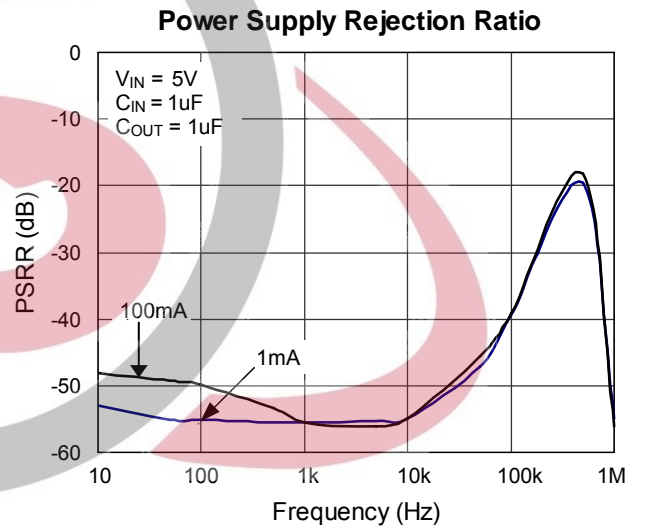
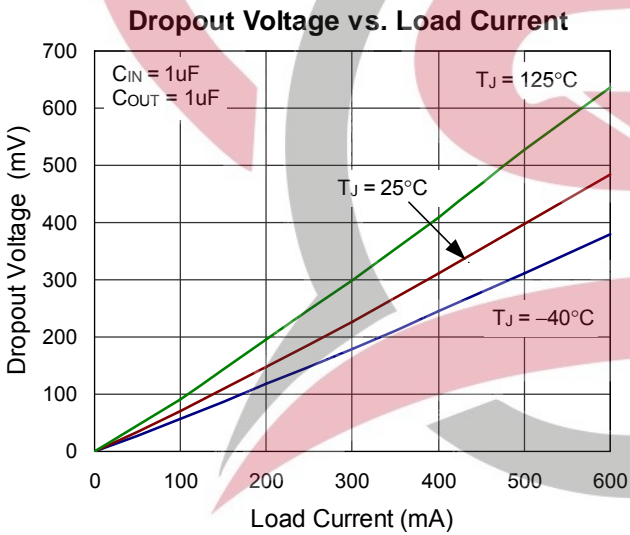
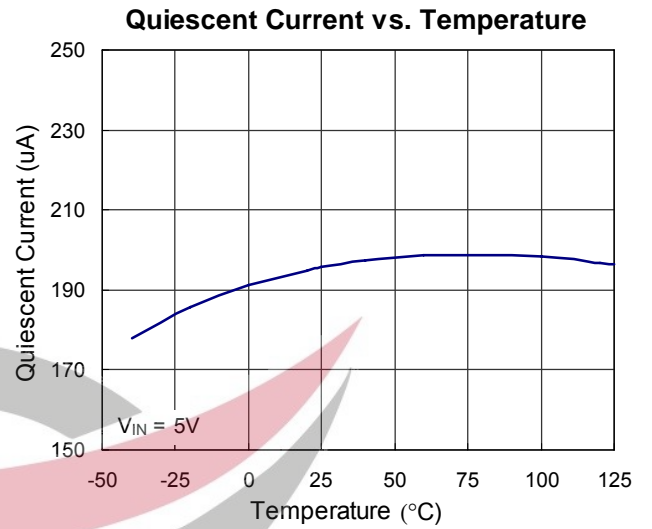
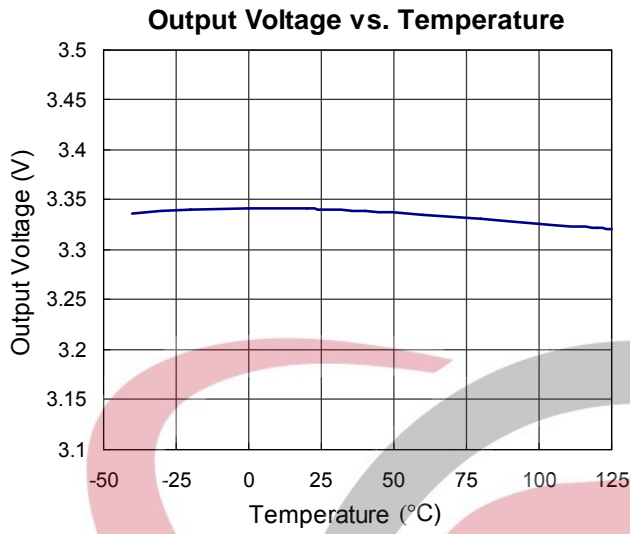

Region of Stable C_{OUT} ESR vs. Load Current

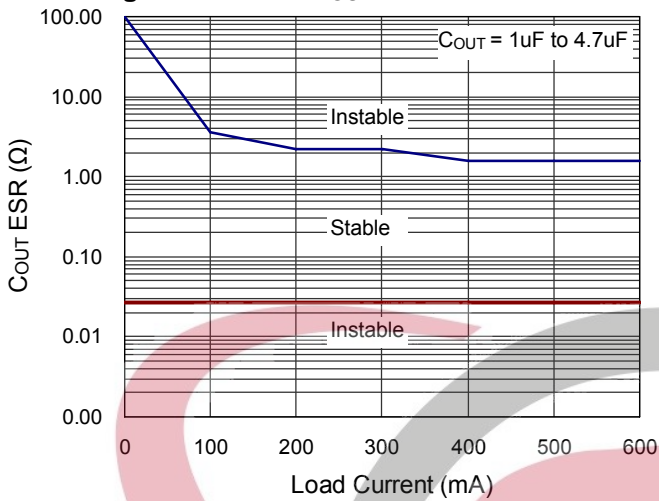

Output Noise

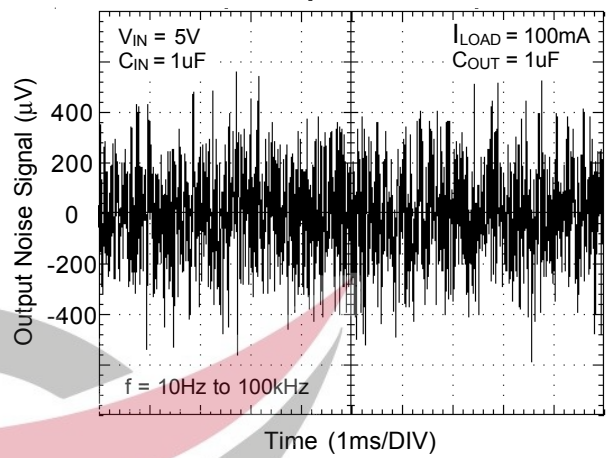

Load Transient Response

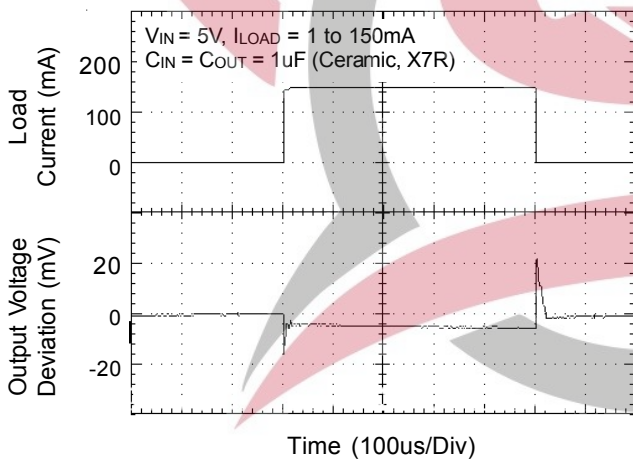

Line Transient Response

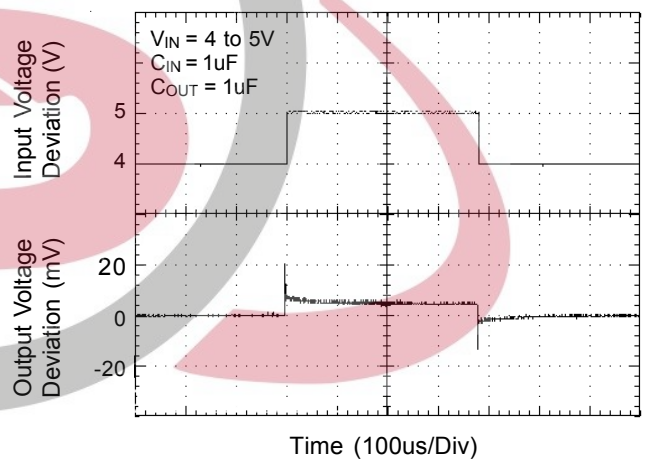

Application Information

Like any low-dropout regulator, the RT9001 series requires input and output decoupling capacitors. These capacitors must be correctly selected for good performance (see Capacitor Characteristics Section). Please note that linear regulators with a low dropout voltage have high internal loop gains which require care in guarding against oscillation caused by insufficient decoupling capacitance.

Input Capacitor

An input capacitance of $\cong 1\mu\text{F}$ is required between the device input pin and ground directly (the amount of the capacitance may be increased without limit). The input capacitor **MUST** be located less than 1 cm from the device to assure input stability. A lower ESR capacitor allows the use of less capacitance, while higher ESR type (like aluminum electrolytic) require more capacitance.

Capacitor types (aluminum, ceramic and tantalum) can be mixed in parallel, but the total equivalent input capacitance/ESR must be defined as above to stable operation.

There are no requirements for the ESR on the input capacitor, but tolerance and temperature coefficient must be considered when selecting the capacitor to ensure the capacitance will be $\cong 1\mu\text{F}$ over the entire operating temperature range.

Output Capacitor

The RT9001 is designed specifically to work with very small ceramic output capacitors. The recommended minimum capacitance (temperature characteristics X7R or X5R) is from $1\mu\text{F}$ to $4.7\mu\text{F}$ ceramic capacitor between LDO output and GND for transient stability, but it may be increased without limit. Higher capacitance values help to improve transient. The output capacitor's ESR is critical because it forms a zero to provide phase lead which is required for loop stability. (When using the Y5V dielectric, the minimum value of the input/output capacitance that can be used for stable over full operating temperature range is $3.3\mu\text{F}$.)

No Load Stability

The device will remain stable and in regulation with no external load. This is specially important in CMOS RAM keep-alive applications.

Input-Output (Dropout) Voltage

A regulator's minimum input-to-output voltage differential (dropout voltage) determines the lowest usable supply voltage. In battery-powered systems, this determines the useful end-of-life battery voltage. Because the device uses a PMOS, its dropout voltage is a function of drain-to-source on-resistance, $R_{\text{DS(ON)}}$, multiplied by the load current :

$$V_{\text{DROPOUT}} = V_{\text{IN}} - V_{\text{OUT}} = R_{\text{DS(ON)}} \times I_{\text{OUT}}$$

Current Limit

The RT9001 monitors output current and controls the PMOS' gate voltage to limit the output current to 600mA (MIN). The output can be shorted to ground for an indefinite period of time without damaging the part.

Short-Circuit Protection

The device is short circuit protected and in the event of a peak over-current condition, the short-circuit control loop will rapidly drive the output PMOS pass element off. Once the power pass element shuts down, the control loop will rapidly cycle the output on and off until the average power dissipation causes the thermal shutdown circuit to respond to servo the on/off cycling to a lower frequency. Please refer to the section on thermal information for power dissipation calculations.

Capacitor Characteristics

It is important to note that capacitance tolerance and variation with temperature must be taken into consideration when selecting a capacitor so that the minimum required amount of capacitance is provided over the full operating temperature range. In general, a good tantalum capacitor will show very little capacitance variation with temperature, but a ceramic may not be as good (depending on dielectric type).

No Load Stability

The device will remain stable and in regulation with no external load. This is specially important in CMOS RAM keep-alive applications.

Aluminum electrolytics also typically have large temperature variation of capacitance value.

Equally important to consider is a capacitor's ESR change with temperature: this is not an issue with ceramics, as their ESR is extremely low. However, it is very important in Tantalum and aluminum electrolytic capacitors. Both show increasing ESR at colder temperatures, but the increase in aluminum electrolytic capacitors is so severe they may not be feasible for some applications.

Ceramic:

For values of capacitance in the 10µF to 100µF range, ceramics are usually larger and more costly than tantalums but give superior AC performance for by-passing high frequency noise because of very low ESR (typically less than 10mΩ). However, some dielectric types do not have good capacitance characteristics as a function of voltage and temperature.

Z5U and Y5V dielectric ceramics have capacitance that drops severely with applied voltage. A typical Z5U or Y5V capacitor can lose 60% of its rated capacitance with half of the rated voltage applied to it. The Z5U and Y5V also exhibit a severe temperature effect, losing more than 50% of nominal capacitance at high and low limits of the temperature range.

X7R and X5R dielectric ceramic capacitors are strongly recommended if ceramics are used, as they typically maintain a capacitance range within ±20% of nominal over full operating ratings of temperature and voltage. Of course, they are typically larger and more costly than Z5U/Y5U types for a given voltage and capacitance.

Tantalum:

Solid tantalum capacitors are recommended for use on the output because their typical ESR is very close to the ideal value required for loop compensation. They also work well as input capacitors if selected to meet the ESR requirements previously listed.

Tantalums also have good temperature stability: a good quality tantalum will typically show a capacitance value that varies less than 10 to 15% across the full temperature range of 125°C to -40°C. ESR will vary only about 2X going from the high to low temperature limits.

The increasing ESR at lower temperatures can cause oscillations when marginal quality capacitors are used (if the ESR of the capacitor is near the upper limit of the stability range at room temperature).

Aluminum:

This capacitor type offers the most capacitance for the money. The disadvantages are that they are larger in physical size, not widely available in surface mount, and have poor AC performance (especially at higher frequencies) due to higher ESR and ESL.

Compared by size, the ESR of an aluminum electrolytic is higher than either Tantalum or ceramic, and it also varies greatly with temperature. A typical aluminum electrolytic can exhibit an ESR increase of as much as 50X when going from 25°C down to -40°C.

It should also be noted that many aluminum electrolytics only specify impedance at a frequency of 120Hz, which indicates they have poor high frequency performance. Only aluminum electrolytics that have an impedance specified at a higher frequency (between 20kHz and 100kHz) should be used for the device. Derating must be applied to the manufacturer's ESR specification, since it is typically only valid at room temperature.

Any applications using aluminum electrolytics should be thoroughly tested at the lowest ambient operating temperature where ESR is maximum.

Thermal Considerations

Thermal protection limits power dissipation in RT9901. When the operation junction temperature exceeds 170°C, the OTP circuit starts the thermal shutdown function and turns the pass element off. The pass element turns on again after the junction temperature cools by 40°C. For continuous loading operation, do not exceed absolute maximum operation junction temperature 125°C. The power dissipation definition in device is:

$$P_D = (V_{IN} - V_{OUT}) I_{OUT} + V_{IN} I_{GND}$$

The final operating junction temperature for any set of conditions can be estimated by the following thermal equation :

$$P_{D(MAX)} = (T_{J(MAX)} - T_A) / \theta_{JA}$$

Where $T_{J(MAX)}$ is the maximum junction temperature of the die ($125^{\circ}C$) and T_A is the ambient temperature. The junction to ambient thermal resistance (θ_{JA}) for SOT-223 package at recommended minimum footprint is $160^{\circ}C/W$ (θ_{JA} is layout dependent). Visit our website in which "Recommended Footprints for Soldering Surface Mount Packages" for detail.



Outline Dimension

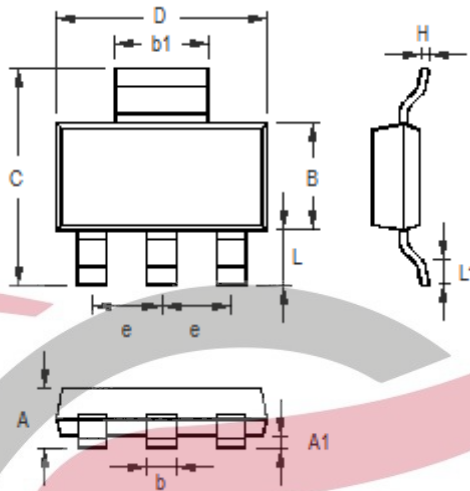

Symbol	Dimensions In Millimeters		Dimensions In Inches	
	Min	Max	Min	Max
A	1.400	1.800	0.055	0.071
A1	0.020	0.100	0.001	0.004
b	0.600	0.840	0.024	0.033
B	3.300	3.700	0.130	0.146
C	6.700	7.300	0.264	0.287
D	6.300	6.700	0.248	0.264
b1	2.900	3.100	0.114	0.122
e	2.300		0.091	
H	0.230	0.350	0.009	0.014
L	1.500	2.000	0.059	0.079
L1	0.800	1.100	0.031	0.043

3-Lead SOT-223 Surface Mount Package

Richtek Technology Corporation

Headquarter
 5F, No. 20, Taiyuen Street, Chupei City
 Hsinchu, Taiwan, R.O.C.
 Tel: (8863)5526789 Fax: (8863)5526611

Richtek Technology Corporation

Taipei Office (Marketing)
 5F, No. 95, Minchiuan Road, Hsintien City
 Taipei County, Taiwan, R.O.C.
 Tel: (8862)86672399 Fax: (8862)86672377
 Email: marketing@richtek.com

Information that is provided by Richtek Technology Corporation is believed to be accurate and reliable. Richtek reserves the right to make any change in circuit design, specification or other related things if necessary without notice at any time. No third party intellectual property infringement of the applications should be guaranteed by users when integrating Richtek products into any application. No legal responsibility for any said applications is assumed by Richtek.